

Article number: 46915512

Description: Torque limiter Safeguard A 55 M

Measures

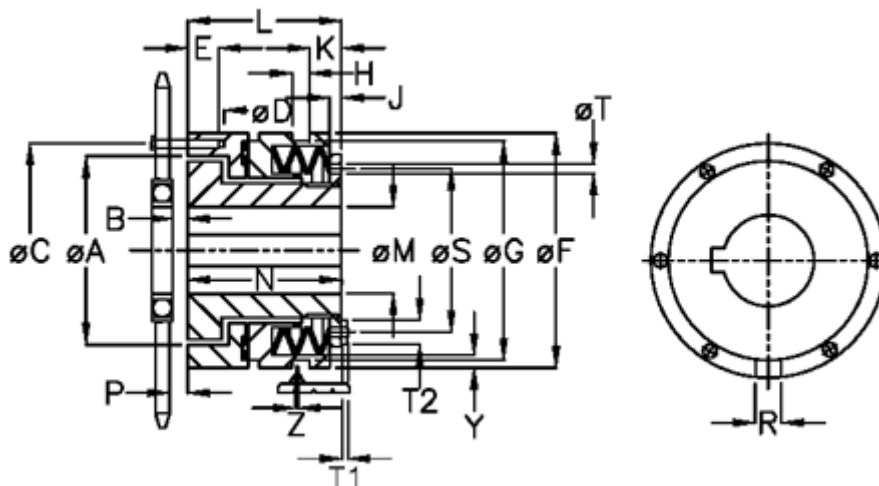

A	= 105.0	G	= 140.0	P	= 4.0
B	= 7.0	H	= 9	R	= 12
C	= 125	J	= 11.0	S	= 104
D	= 6xM10	K	= 27.0	T	= 7
Disc spring mounting	= 5x1M	L	= 100.0	T1	= 6.0
Disc spring version	= M - medium	M max	= 55	T2	= 13
E	= 15.0	M min	= 24	Y	= 2
F	= 146	N	= 94.0	Z	= 0.0